

Link-Belt
CONSTRUCTION EQUIPMENT

HTC-1170

Hydraulic Truck Crane

- 70 Ton (63.55 metric ton) Capacity
- 98,202 lbs. (44 544 kg) Working Weight
- 187 ft. (57.00 m) Maximum On-Board Tip Height
- 199 ft. (60.66 m) Maximum Available Tip Height

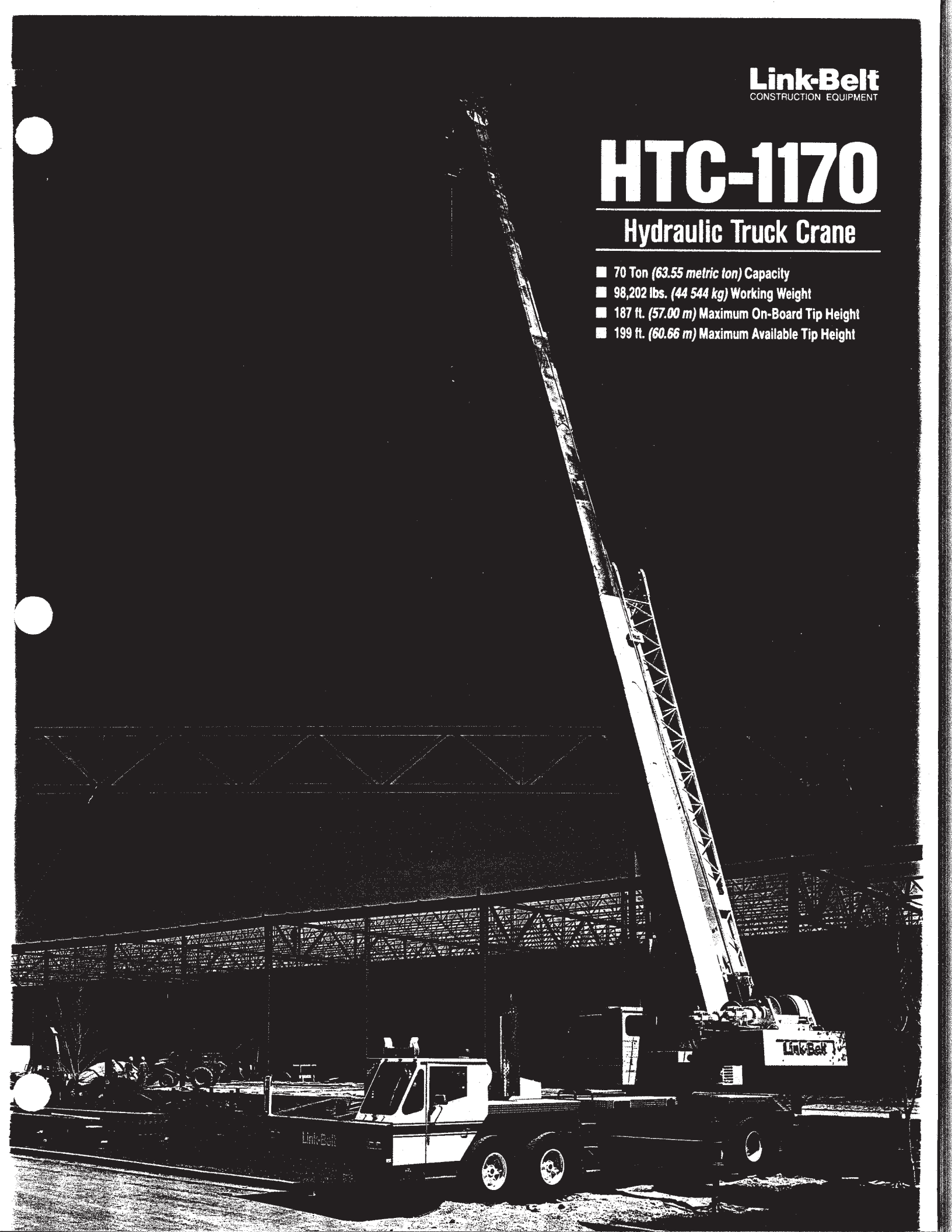

The HTC-1170 puts you in complete control

Operator Control Center Designed for maximum operator comfort and control with these features:

- › Six-way adjustable fabric seat.
- › Boom telescope overrides allow operating flexibility of powered sections.
- › Arm rest mounted dual hydraulic controllers.
- › Electronic drum rotation indicators.
- › Single foot pedal control for simultaneous extension or retraction of power boom sections.

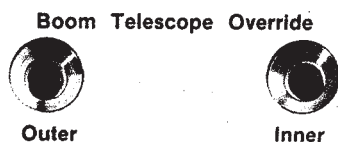

Additional Cab Features Include:

- › Large front window for excellent visibility.
- › Tinted glass.
- › Sliding right side and rear windows and swing-up top window provide excellent ventilation.

WARNING

- › Load Moment Indicator aids the operator in safe and efficient operation by continuously displaying machine configuration, boom angle, boom length, radius, height, allowed load, actual load, and percent of allowable load. Both audio and visual alarms warn the operator of an overload or two-block condition.



Lift-up Arm Rest

Left arm rest lifts up out of the way providing outstanding operator ease in entering or exiting cab. For safety, all control functions become inactive when the arm rest is in raised position.

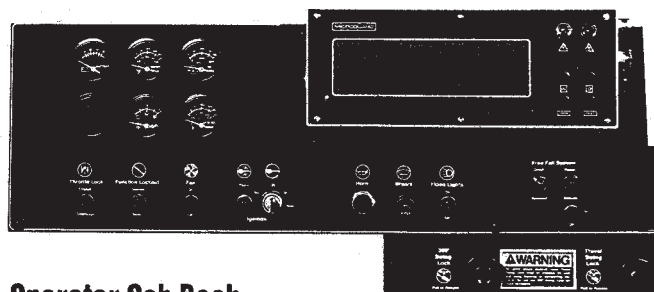
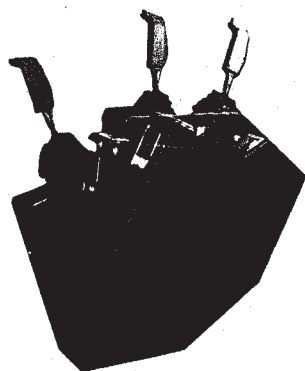

Operator Cab Dash

Dash panel provides easy control access for the operator. Conveniently located, this panel houses switches for wiper, fan, lights, horn, function lockout, freefall, ignition and throttle lock. Mechanical controls are provided for 360° swing lock and travel swing lock. Toggle switches are rubber encased for protection against dust and moisture. Comprehensive and easy to read gauges monitor air pressure, hydraulic oil temperature, battery charge, fuel level, water temperature and engine oil pressure.

Outrigger Controls

Outrigger controls are conveniently located in the left arm rest of operator's control center. Outrigger controls are also provided on each side of carrier at ground level.

GENERAL INFORMATION ONLY

Continuous Innovation . .

The New HTC-1170 The all new HTC-1170 expands Link-Belt's role as the premier choice of state-of-the-art hydraulic cranes. Fast to become an industry leader, the HTC-1170 features superior capacities and attachment flexibility while maintaining gross vehicle weight for transportability.

Job-to-Job Transportability

The HTC-1170 has a roadable weight of 98,202 lbs. (44 544 kg) complete with 187 ft. (57.00 m) of on-board tip height.

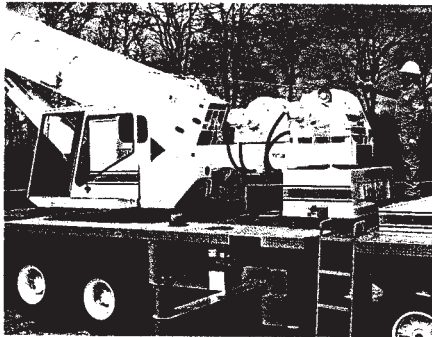

To meet specific road laws, the HTC-1170's overall weight can be reduced to under 90,000 lbs. (40 824 kg) by removing the counterweight. This operation can be performed quickly by using the available on-board counterweight removal system.

Carrier The Link-Belt design philosophy incorporates 100,000 psi steel to achieve maximum rigidity and torsional strength while reducing weight for roadability.

Proven drive train components are matched for reliability and excellent travel speeds of over 48 mph (77.23 km/h). An available automatic transmission provides the HTC-1170 with the most engine and transmission combinations in its class.

Link-Belt's 8 x 4 carrier also features reinforced 12 gauge sheet metal fenders and large engine access doors for serviceability. Aluminum "diamond plate" fenders are also available.

Carrier Cab The acoustically treated carrier cab assures the operator of highway comfort and control with the standard tilt/telescoping steering wheel connected to rack and pinion steering. Additional comfort and safety features include dash-mounted comprehensive instrumentation with lighted gauges, rear sliding and roll-down door windows for excellent ventilation, fully adjustable, fabric seat with arm rests, aluminum non-skid "diamond plate" floor, suspended pedals, rear view mirrors and resettable circuit breakers.

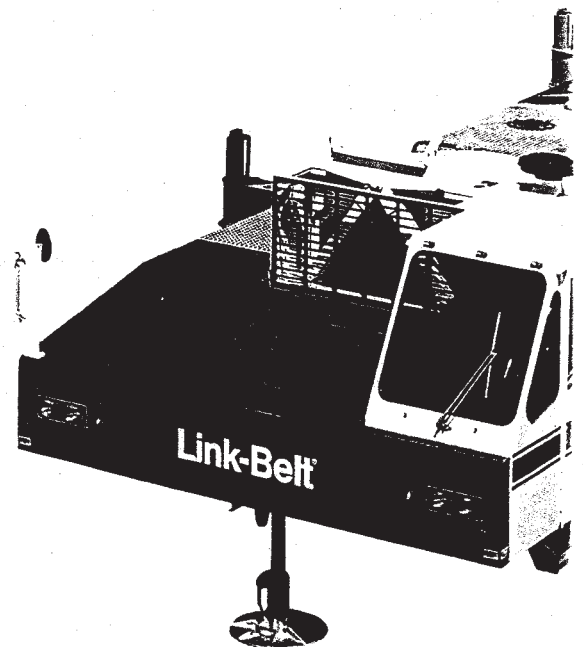
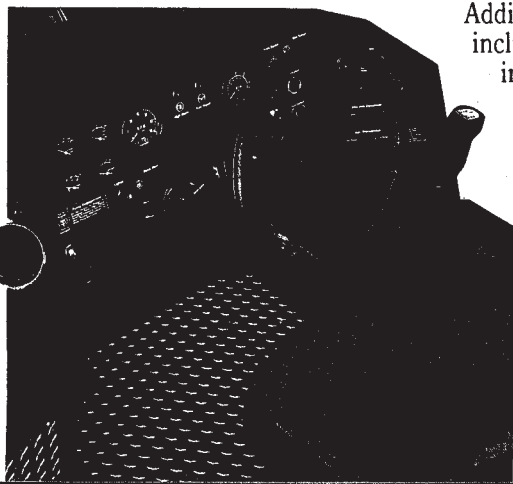

Designed Flexibility.

Hoist System Matched To Your Job Requirements

- › 2 design types
- › Equal size main and auxiliary winches sized to machine capacity
- › Freefall — Link-Belt exclusive design

Model 2M Winch

Two speed power up/power down

Two speed hydraulic motor, planetary drive with integral automatic brake.

Matched sizes of main and auxiliary winches provide equal maximum available line pulls of 15,870 lbs. (7 199 kg) and maximum line speeds of 548 feet per minute (167.03 m/min.) on 17" (0.43 m) root diameter drums.

Model 3M Winch

Two speed power up/power down PLUS

True Gravity Controlled Freefall.

Two speed hydraulic motor, planetary drive with integral automatic brake PLUS

Link-Belt's exclusive drum brake assembly — available on main and auxiliary winches.

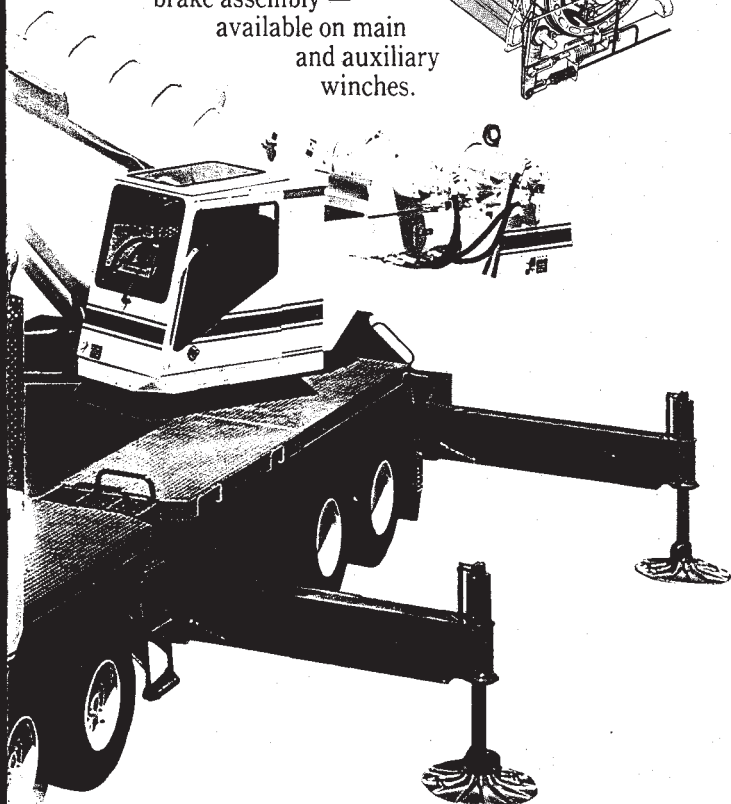
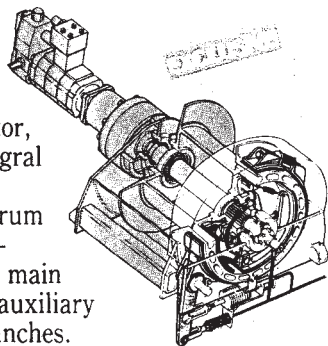

The model 3M winch is activated by 3 simple steps that provides the user unsurpassed performance in duty cycle operation.

This system enables loads to be returned to the ground faster for increased productivity. The system has built-in overrides that prevent inadvertent activation of the freefall system. The 3M winch features:

- › Dual independent braking system
- › Cooler running hydraulic system
- › Less component wear
- › High line speeds

Designed-In Added Value

Reliable components and access to serviceable items

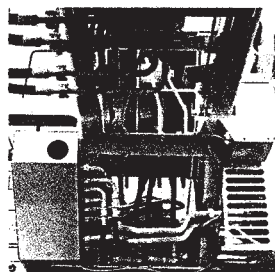

Simplified Routings All Link-Belt hydraulic cranes incorporate well thought out routings for easy access. Fittings and connections are staggered where necessary for quick and easy servicing.

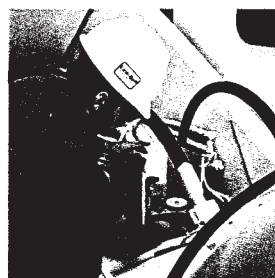

Accessible Collector Ring Quick removal of a protective cover exposes the collector ring, with the boom at any angle.

Circuit Breakers Circuit breakers, mounted in both control stations, are easily resettable within reach of the operator. No fuses or in-line problems.

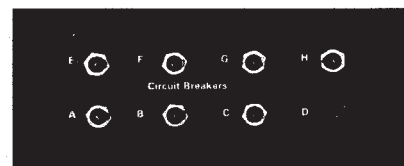

State-of-the-Art Wire Harness

The HTC-1170 has Packard XL automotive-type wire harnesses throughout for outstanding long term reliability.



Patented boom design

EXCLUSIVE



Embossed sidewall stiffeners with no-weld corners

Boom Concept The arrangement of high strength angle chords (corners) with high formability steel sidewalls (embossments) places the most steel at corners where maximum stress is concentrated.

The result: maximum strength with minimum weight.

Embossed Sidewall Stiffeners Increases sidewall stiffness.

Sidewall Design Concept Not only do the embossments increase sidewall stiffness, but because of their placement they naturally transfer stresses uniformly to the high strength angle chords (corners)—a concept derived from Link-Belt lattice boom technology.

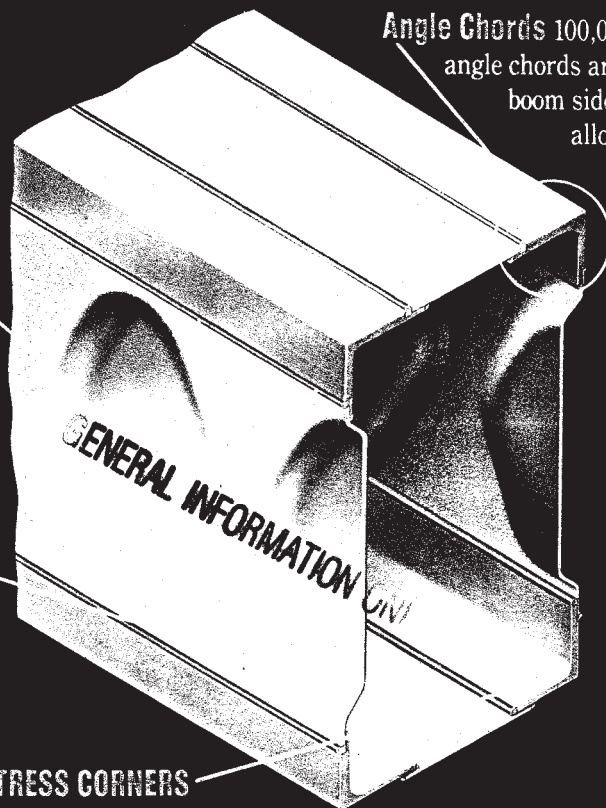

Angle Chords 100,000 psi high strength steel angle chords are precision machined for boom sidewall overlap. This design allows all interior and exterior boom welds to be offset or staggered for maximum structural integrity.

Time Proven Boom Design Over a decade and thousands of hydraulic crane booms later, Link-Belt's exclusive, patented design is unchanged—state-of-the-art—before its time; providing superior capacities, tip heights and reliability.

It is true testimony to Link-Belt's engineering design achievement that this design concept is being imitated today for optimum performance.

NO WELDS IN HIGH STRESS CORNERS

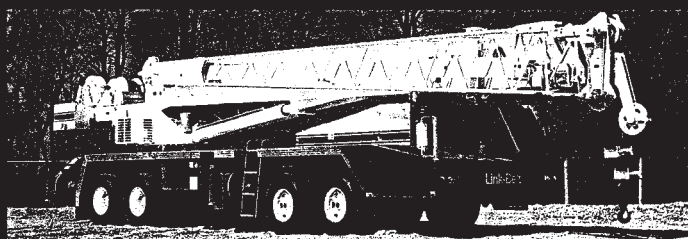
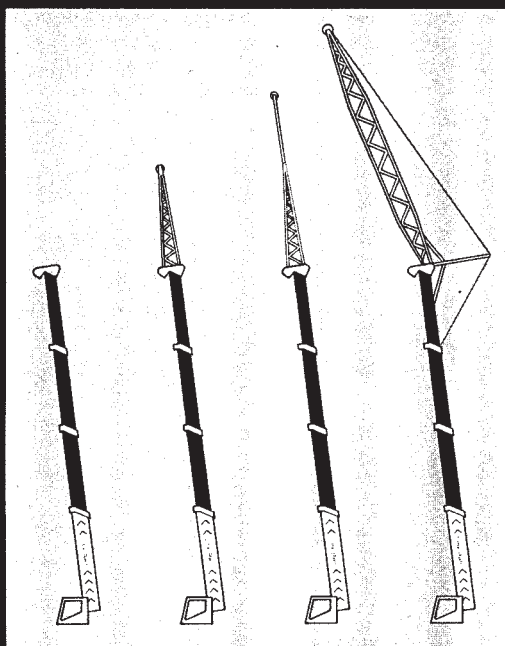

Stowable Attachments

Swing-away lattice flies are easily stored for transportability or can be removed to meet specific road laws.

Attachment Flexibility

Your choice:

- 120'6" (36.73 m) four section boom with power pinned tip section.
- 35' (10.67 m) stowable one piece lattice fly—offsets to 2°, 15° or 30°.
- 35' (10.67 m) - 61' (18.59 m) stowable lattice fly with telescopic box section—offsets to 2°, 15° or 30°.
- 75' (22.86 m) tubular lattice jib—offsets to 5°, 17.5°, 30° or 45°.

HTC-1170 Specifications

Boom Standard—38'0" - 120'6" (11.58 m - 36.73 m) 4-section power pinned boom includes base, two power sections and power pinned fourth section. Load moment indicator with function kickout.

Boom head—Standard are five 14-1/4" (0.36 m) root diameter head sheaves to handle up to 10 parts of 3/4" (19 mm) wire rope.

Optional auxiliary lifting sheave—single 16-1/2" (0.42 m) root diameter sheave.

Boom elevation—Boom elevation from -3° to 80°.

Fly Stowable 35'0" (10.67 m) one-piece lattice type. Can be offset 2°, 15° or 30°.

Fly Optional—35'0" - 61'0" (10.67 m - 18.59 m) lattice fly with telescopic box section. Can be offset 2°, 15° or 30°.

Jib Optional—75'0" (22.86 m) lattice jib. Can be offset 5°, 17.5°, 30° or 45°.

Cab and Controls

Environmental cab; isolated from sound and vibration by rubber mounts. All tinted and tempered safety glass windows. Slide-by-door opens to 3'0" (0.91 m) width. Six-way adjustable operator's seat. Joy stick controllers

for swing, winches and boom hoist. Foot controls for swing brake and boom telescope.

Cab instrumentation—Dash mounted gauges include air pressure gauge, voltmeter, hydraulic oil temperature gauge, fuel gauge, water temperature gauge, oil pressure gauge and tachometer. Dash mounted switches for ignition, throttle lock, lights and windshield wiper. Outrigger controls mounted under left armrest.

Swing Bi-directional hydraulic swing motor mounted to a planetary reducer for 360° continuous smooth swing at 2.45 r.p.m. **Swing brake**—Foot actuated 360° manually applied, spring released disc brake mounted on speed reducer.

Travel lock—Two position house lock for travel or pick and carry modes.

Swing lock—360° position pin-type controlled from the operator's cab.

Counterweight Pinned to upperstructure frame. Counterweight removal system available.



Hydraulic System Main pumps are (2) two-section gear-type pumps. Powered by carrier engine with manual pump disconnect which is operated from carrier cab. Maximum system pressure 3,150 p.s.i. (221.4 kg/cm²). Hydraulic oil cooler.

Reservoir—Link-Belt, 173 gallon (654.87 Liters) capacity. Diffusers for deaeration.

Filtration—One six-micron filter located inside the hydraulic reservoir.

Control valves—Separate control valves for each crane function. All valves pilot operated.

Load Hoist System Model 2M main winch with two-speed motor and automatic brake; power up/power down mode of operation. Bi-directional gear type hydraulic motor.

Optional—Model 2M auxiliary winch.

Optional—Model 3M winch with power up/power down, two-speed motor and exclusive controlled true gravity freefall. Available on main or both winches.

Line pulls and speeds—Maximum available line pull is 15,870 lbs. (7,199 kg) and maximum line speed is 548 f.p.m. (167.03 m/min) on 17" (0.43 m) root diameter drums.

Carrier Link-Belt 8 x 4 drive, 11'0" (3.35 m) wide, 233" (5.92 m) wheelbase.

Frame All welded high strength alloy steel plate construction with box-type design and integral 100,000 p.s.i. (689.5 MPa) steel outrigger boxes.

Engine Cummins NTA-C310, 310 H.P. @ 2,100 rpm (49 states)

Optional—Cummins NTA-C400, 400 H.P. @ 2,100 rpm. (49 states)

Optional—Cummins N14-330, 330 H.P. @ 1,950 rpm. (California)

Optional—Cummins N14-410, 410 H.P. @ 1,950 rpm. (California)

Fuel Tank 100 gal. (378.5 Liters)

Outriggers Power hydraulic, double box, single beam outriggers, front and rear. Beams extend to 23'6" (7.16 m) centerline-to-centerline. Equipped with stowable, aluminum 30-1/2" (.77 m) diameter floats.

Bumper outrigger—A front center vertical jack mounted under bumper with 24" (0.61 m) diameter aluminum float.

Axles

Front—tandem; 109" (2.77 m) track.

Rear—tandem; 100.65" (2.56 m) track, 6.14 to 1.0 ratio with interaxle differential lockout for Cummins NTA engines, and 7.14 to 1.0 ratio with interaxle differential lockout for Cummins N14 engines.

Suspension

Front—Spring suspension with torque rods.

Rear—Solid mount 54" (1.37 m) bogie beam.

Wheels Cast, six-spoke.

Tires Front - 14R20 radials

Rear - 14R20 radials

Optional - 445/65R22.5 radials

Brakes

Front—S-cam type, 16.5" x 6" (.42 m x .15 m) shoe diameter, 760 sq. in. (4904 cm²).

Rear—S-cam-type, 16.5" x 7" (.42 m x .18 m) shoe diameter, 968 sq. in. (6245 cm²).

Steering Sheppard Steering, rack-and-pinion design. Provides a wall-to-wall turning radius of 50'0" (15.24 m).

Clutch 14" (0.36 m) diameter with Cummins NTA-C310, spring loaded, double plate dry disc. 15.5" (.39 m) diameter double plate with Cummins NTA-C400, N14-330 and N14-410.

Transmissions Fuller Roadranger; 9 speeds forward, 2 reverse.

Optional - Allison HT750DR automatic (available on NTA-C400 engine only)

Auxiliary - Fuller AT-1202; 2 speed, high/low range. Provide creep speeds for pick-n-carry applications.

Electrical System Two 12-volt batteries; 2,160 cold cranking amps available, 80 amp alternator with Cummins NTA engines. 90 amp alternator with Cummins N14 engines.

Lights Four dual-beam sealed headlights, front and rear directional signals, stop and taillights, four way emergency flashers, backup lights, front, rear and side clearance lights with integral reflectors and license plate light.

Carrier Cab One man, acoustically treated, rear view mirrors, heater, forced air defroster, horn, windshield wiper/washer, trailboss seat with seat belt, door window locks, fire extinguisher and tilt/telescoping steering column.

Cab instrumentation—Illuminated instrument panel with speedometer, odometer, tachometer, voltmeter, hourmeter, front and rear air pressure gauges, low air pressure light and warning buzzer, automotive-type ignition (common with upper), engine oil pressure gauge, water temperature gauge, fuel gauge, turn signal indicator, high beam light switch, adjustable defroster vents, and resettable circuit breakers.

Travel Speeds and Gradeability

Engine	Maximum Speed	*Gradeability at peak engine torque
Cummins NTA-C310	48.1 mph (77.39 km/h)	31.71%
Cummins NTA-C400	48.1 mph (77.39 km/h)	37.84%
Cummins N14-330	52.6 mph (84.63 km/h)	49.58%
Cummins N14-410	52.6 mph (84.63 km/h)	53.17%

* Low gear high range

Link-Belt

CONSTRUCTION EQUIPMENT

Link-Belt Construction Equipment Company Lexington, Kentucky

A unit of Sumitomo Construction Machinery Co., Ltd.

© Link-Belt is a registered trademark. Copyright 1993. All rights reserved. We are constantly improving our products and therefore reserve the right to change designs and specifications. Litho in USA 3/93

#4142 (supersedes #4100)